

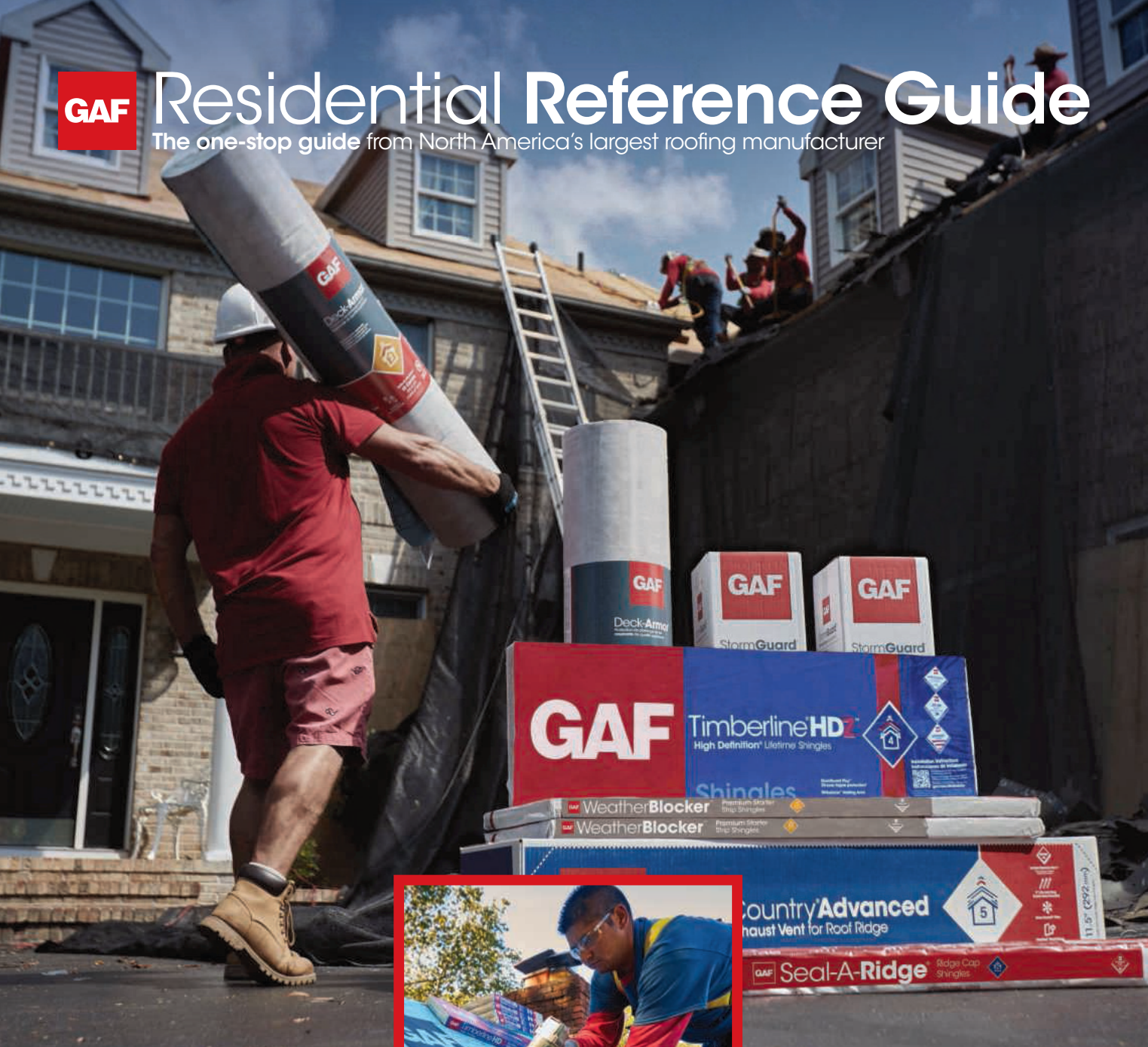

Residential Reference Guide

The one-stop guide from North America's largest roofing manufacturer



GAF shingles and roof accessories are made to work together. They provide a system that's built to protect homes — so the people who live inside them can enjoy what matters most.











We protect what matters most™

Technology Index		3
GAF Lifetime [†] Roofing System LRS		4–5
GAF Shingles		6–19
Timberline[®] Lifetime[†] Shingles Collection LRS		
Timberline [®] Color Availability		7
Timberline HDZ [®]	●	8
Timberline UHDZ [®]	●	9
Timberline [®] NS	●	9
Designer Lifetime[†] Shingles[®] Collection LRS		
Grand Sequoia [®]	●	11
Camelot [®] II	●	12
Woodland [®]	●	12
Slateline [®]	●	13
SBS-Modified IR Shingles Collection LRS		
Timberline [®] AS II	●	15
Grand Sequoia [®] AS	●	15
Reflective Shingles Collection LRS		
Timberline HDZ [®] RS	●	17
Grand Sequoia [®] RS	●	17
3-Tab Shingle Collection (Excluded from LRS)		
Royal Sovereign [®] Color Availability		18
Royal Sovereign [®]		19
Shingle Specifications Chart		20–21
GAF Roofing Accessories LRS		
Leak Barriers	●	23
Roof Deck Protection	●	24
Starter Strip Shingles	●	25
Attic Ventilation	●	26–27
Ridge Cap Shingles	●	28
Other Residential Products		
Master Flow [™] Rooftop Accessory Products		29
WeatherSide [™] Fiber-Cement Siding & Accessories		30
LIBERTY [™] SBS Self-Adhering Roofing System		31



Trust the diamonds

<p>Whether it's warranty coverage that gives homeowners peace of mind or technology that makes their roof look and perform its best, there's a GAF diamond badge behind it.</p>		<p>Install any GAF Lifetime[†] shingle and get a Lifetime[†] Limited Warranty on your qualifying shingle. Install any GAF Lifetime[†] shingle and at least 3 qualifying GAF accessories, and get a Lifetime[†] Limited Warranty on your qualifying GAF products.</p>
		<p>GAF Advanced Protection[®] Shingle Technology uses highly advanced design and manufacturing techniques to produce cutting-edge roofing products.</p>
		<p>Dura Grip[™] adhesive helps protect your roof investment from winds and wind-driven rain.</p>
		<p>Comes with a 25-year StainGuard Plus[™] or 30-year StainGuard Plus PRO[™] (as indicated) Algae Protection Limited Warranty² against blue-green algae discoloration thanks to GAF time-release algae-fighting technology that releases copper over time for long-lasting algae-fighting power.</p>
		<p>StainGuard[®] Algae Protection³ is a 10-year limited warranty against blue-green algae discoloration.</p>
		<p>LayerLock[®] Technology is a proprietary technology that mechanically fuses the common bond between overlapping shingle layers.</p>
		<p>WindProven[™] Limited Wind Warranty¹ is a 15-year limited wind warranty with no maximum wind speed limitation — available when you install the LayerLock[®]-labeled shingles as well as GAF starter strips, roof deck protection, ridge cap shingles, and leak barrier or attic ventilation.</p>
		<p>Patented Dual Shadow Line for sunset shadows all day long.</p>

[†] Lifetime refers to the length of warranty coverage provided and means as long as the original individual owner(s) of a single-family detached residence [or eligible second owner(s)] owns the property where the qualifying GAF products are installed. For other owners/structures, Lifetime coverage is not applicable. Lifetime coverage on shingles requires the use of GAF Lifetime shingles only. See the *GAF Shingle & Accessory Limited Warranty* for complete coverage and restrictions. Visit gaf.com/LRS for qualifying GAF products.

¹ 15-year WindProven[™] Limited Wind Warranty on GAF shingles with LayerLock[®] Technology requires the use of GAF starter strips, roof deck protection, ridge cap shingles, and leak barrier or attic ventilation. See *GAF Roofing System Limited Warranty* for complete coverage and restrictions. Visit gaf.com/LRS for qualifying GAF products. For installations not eligible for the *WindProven[™] Limited Wind Warranty*, see the *GAF Shingle & Accessory Limited Warranty*.

² The 25-year StainGuard Plus[™] or the 30-year StainGuard Plus PRO[™] Algae Protection Limited Warranty against blue-green algae discoloration are available only on products sold in packages bearing the appropriate StainGuard Plus[™] or StainGuard Plus Pro[™] logos. See *GAF Shingle & Accessory Limited Warranty* for complete coverage and restrictions, and qualifying products.

³ 10-year StainGuard[®] Algae Protection Limited Warranty against blue-green algae discoloration is available only on products sold in packages bearing the StainGuard[®] logo. See *GAF Shingle & Accessory Limited Warranty* for complete coverage and restrictions, and qualifying products.

Trust the system that's built to protect

A roof is so much more than shingles. It's layers of protection, working together to help keep your home safe from wind, rain, snow, and even sun.

Install any GAF Lifetime⁺ shingle and at least 3 qualifying GAF accessories and get a Lifetime⁺ Limited Warranty on your qualifying GAF products plus non-prorated coverage for the first 10 years. For even stronger coverage, ask your GAF factory-certified contractor¹ about enhanced GAF warranties.

Visit gaf.com/LRS for a list of qualifying GAF products.



Visit gaf.com/Lifetime

¹ Contractors enrolled in GAF certification programs are not employees or agents of GAF, and GAF does not control or otherwise supervise these independent businesses. Contractors may receive benefits, such as loyalty rewards points and discounts on marketing tools from GAF for participating in the program and offering GAF enhanced warranties, which require the use of a minimum amount of GAF products. Your dealings with a Contractor, and any services they provide to you, are subject to the *Contractor Terms of Use*. Visit gaf.com/gaf-contractor-terms-of-use for details.

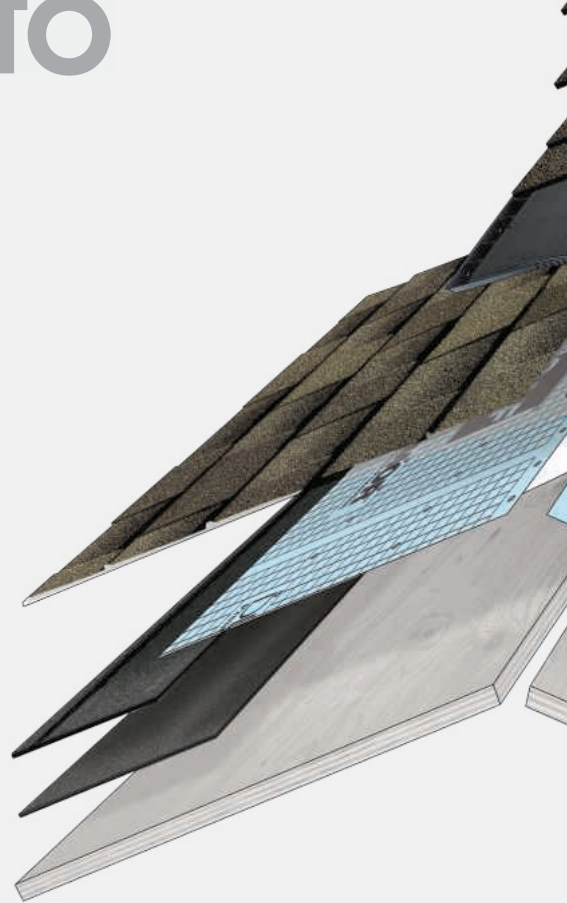

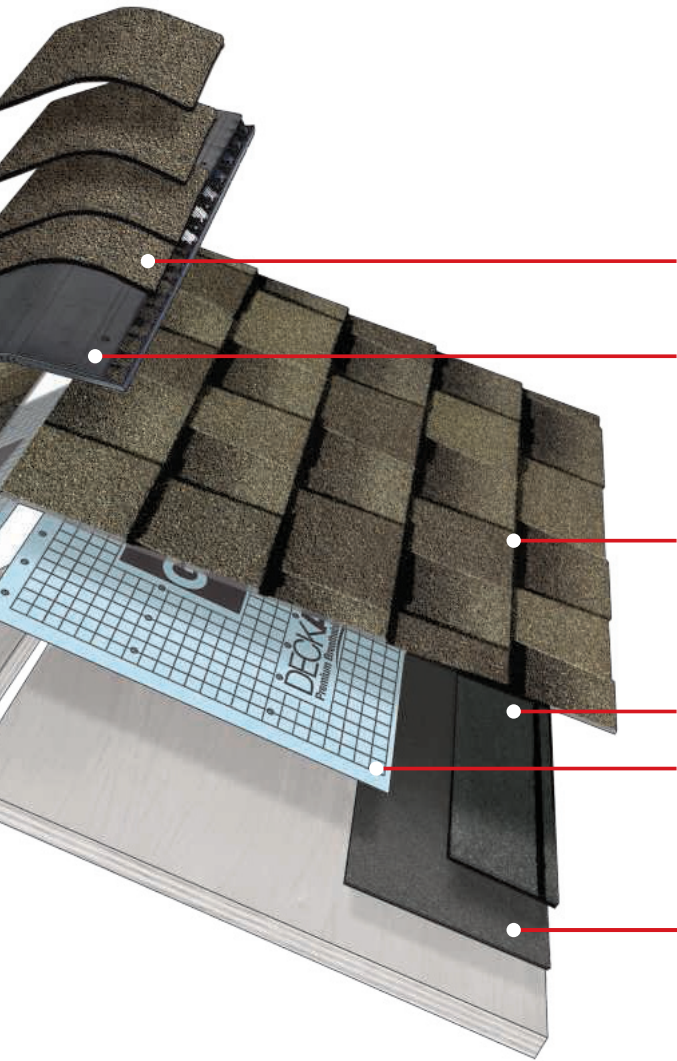



- Ridge Cap Shingles



- Attic Ventilation

- Lifetime⁺ Shingles

- Starter Strip Shingles

- Roof Deck Protection



- Leak Barrier



*Lifetime refers to the length of warranty coverage provided and means as long as the original individual owner(s) of a single-family detached residence [or eligible second owner(s)] owns the property where the qualifying GAF products are installed. For other owners/structures, Lifetime coverage is not applicable. Lifetime coverage on shingles requires the use of GAF Lifetime shingles only. See the *GAF Shingle & Accessory Limited Warranty* for complete coverage and restrictions. Visit gaf.com/LRS for qualifying GAF products. Lifetime coverage on shingles and accessories requires the use of any GAF Lifetime shingle and at least 3 qualifying GAF accessories. See the *GAF Roofing System Limited Warranty* for complete coverage and restrictions. For installations not eligible for the *GAF Roofing System Limited Warranty*, see the *GAF Shingle & Accessory Limited Warranty*. Visit gaf.com/LRS for qualifying GAF products.

Timberline® Lifetime[†] Shingles Collection

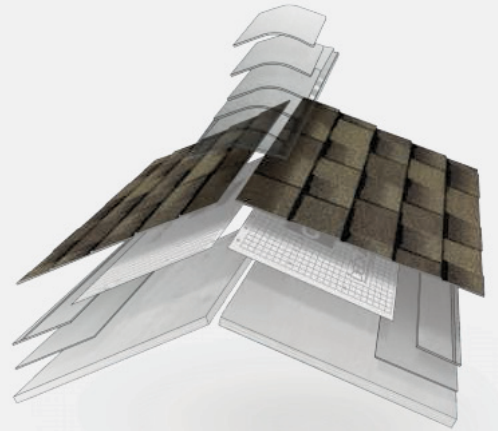
More homeowners in North America rely on Timberline® shingles than any other brand. They offer just the right combination of beauty, performance, and reliability.



<p>Timberline HDZ®</p> <p>pg 7-8</p>			<p>GAF #1-selling shingle—featuring the industry's widest nail zone</p>
<p>Timberline UHDZ®</p> <p>pg 7 & 9</p>			<p>For a highly dimensional wood-shake look in an asphalt shingle</p>
<p>Timberline® NS</p> <p>pg 10</p>			<p>The beauty of natural wood shakes in an asphalt shingle</p>

For specifications see pages 20-21



For the full collection visit gaf.com/Timberline

¹ 15-year WindProven™ Limited Wind Warranty on GAF shingles with LayerLock® Technology requires the use of GAF starter strips, roof deck protection, ridge cap shingles, and leak barrier or attic ventilation. See *GAF Roofing System Limited Warranty* for complete coverage and restrictions. Visit gaf.com/LRS for qualifying GAF products. For installations not eligible for the *WindProven™ Limited Wind Warranty*, see the *GAF Shingle & Accessory Limited Warranty*.

² 10-year StainGuard™, 15-year StainGuard Plus™, and 30-year StainGuard Plus PRO™ Algae Protection Limited Warranties (as indicated) against blue-green algae discoloration is available only on products sold in packages bearing the StainGuard™, StainGuard Plus™, or StainGuard Plus PRO™ logos. See *GAF Shingle & Accessory Limited Warranty* for complete coverage, restrictions, and qualifying products.



Color Availability

Timberline HDZ®

Most Popular Colors:

	1	2	3	4	5	6	7
Barkwood	•	•	•	•	•	•	•
Charcoal	•	•	•	•	•	•	•
Hickory	•	•	•	•	•	•	•
Hunter Green	•	•	•	•	•	•	•
Mission Brown	•	•	•	•	•	•	•
Pewter Gray	•	•	•	•	•	•	•
Shakewood	•	•	•	•	•	•	•
Slate	•	•	•	•	•	•	•
Weathered Wood	•	•	•	•	•	•	•

Harvest Blend Colors:

Appalachian Sky	•	•	•	•	•	•	•
Nantucket Morning	•	•	•	•	•	•	•
Golden Harvest	•	•	•	•	•	•	•
Cedar Falls	•	•	•	•	•	•	•

Regional Colors:

Biscayne Blue	•	•	•	•	•	•	•
Birchwood ²	•	•	•	•	•	•	•
Copper Canyon ²	•	•	•	•	•	•	•
Driftwood	•	•	•	•	•	•	•
Fox Hollow Gray	•	•	•	•	•	•	•
Golden Amber ^{1,2}	•	•	•	•	•	•	•
Oyster Gray	•	•	•	•	•	•	•
Patriot Red	•	•	•	•	•	•	•
Sunset Brick	•	•	•	•	•	•	•
Williamsburg Slate	•	•	•	•	•	•	•

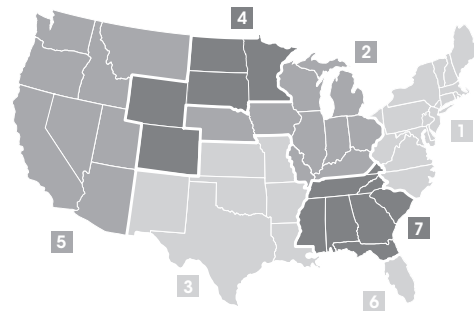

Timberline UHDZ®

Most Popular Colors:

Barkwood	•
Charcoal	•
Pewter Gray	•
Shakewood	•
Slate	•
Weathered Wood	•

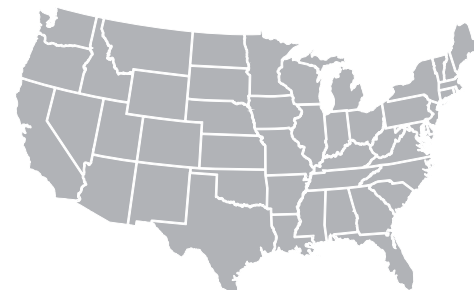

¹ Limited availability.

² Rated by the Cool Roof Rating Council (CRRCC) and can be used to comply with 2022 Title 24, Part 6, Cool Roof Requirements of the California Code of Regulations.

GAF **TimberlineHDZ**[®]
High Definition[®] Lifetime¹ Shingles



With time-release algae-fighting technology and LayerLock[®], Timberline HDZ[®] offers everything you can expect from an architectural shingle roof, and more.

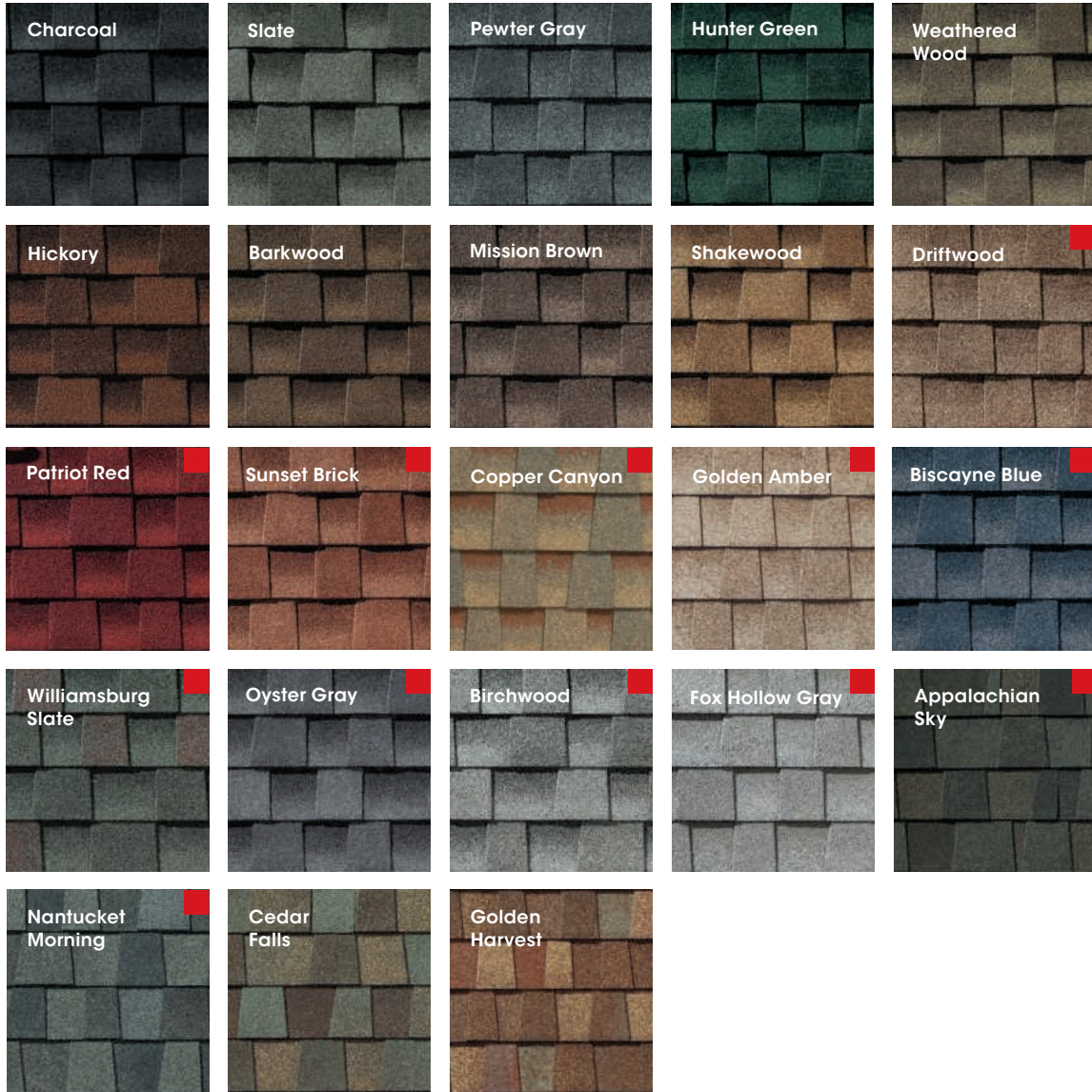

For more details visit gaf.com/hdz

¹ 15-year WindProven™ Limited Wind Warranty on GAF shingles with LayerLock® Technology requires the use of GAF starter strips, roof deck protection, ridge cap shingles, and leak barrier or attic ventilation. See *GAF Roofing System Limited Warranty* for complete coverage and restrictions. Visit gaf.com/LRS for qualifying GAF products. For installations not eligible for the *WindProven™ Limited Wind Warranty*, see the *GAF Shingle & Accessory Limited Warranty*.

² 25-year StainGuard Plus™ Algae Protection Limited Warranty against blue-green algae discoloration is available only on products sold in packages bearing the StainGuard Plus™ logo. See *GAF Shingle & Accessory Limited Warranty* for complete coverage and restrictions.

NOTE: It is difficult to reproduce the color clarity and actual color blends of these products. Before selecting your color, please ask to see several full-size shingles.

Available regionally

GAF Timberline UHDZ®

Ultra High Definition® Lifetime+ Shingles



Timberline UHDZ® Shingles feature a Dual Shadow Line for dramatic sunset shadows and offer a 30-year StainGuard Plus PRO™ Limited Warranty against blue-green algae discoloration¹.

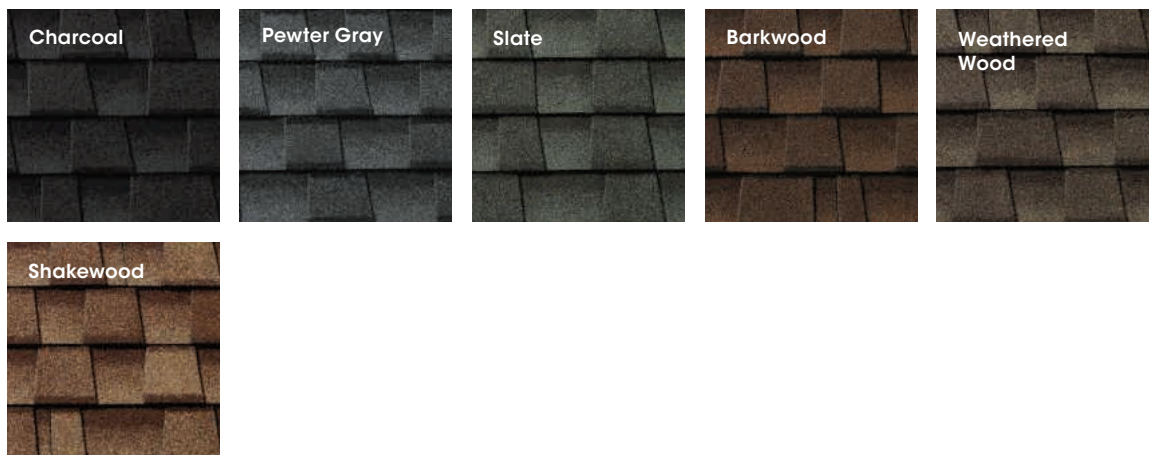

For more details visit gaf.com/uhdz

GAF Timberline NS®

Natural Shadow® Lifetime+ Shingles



These stylish yet practically priced architectural shingles provide value and performance with a classic shadow effect.

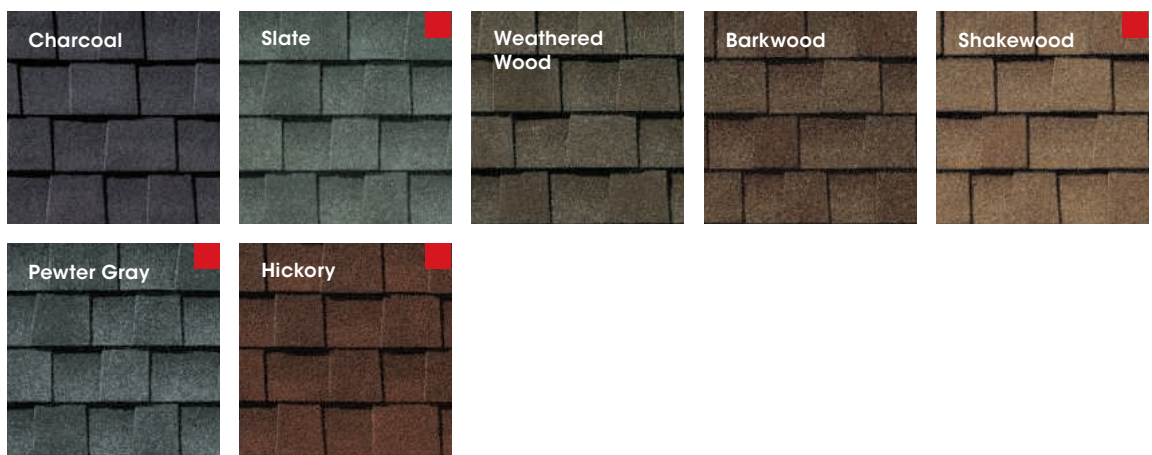

For more details visit gaf.com/ns

¹ 10-year StainGuard™ and 30-year StainGuard Plus PRO™ Algae Protection Limited Warranty against blue-green algae discoloration is available only on products sold in packages bearing the StainGuard™ or StainGuard Plus PRO™ logo. See *GAF Shingle & Accessory Limited Warranty* for complete coverage and restrictions.

² 15-year WindProven™ Limited Wind Warranty on GAF shingles with LayerLock® Technology requires the use of GAF starter strips, roof deck protection, ridge cap shingles, and leak barrier or attic ventilation. See *GAF Roofing System Limited Warranty* for complete coverage and restrictions. Visit gaf.com/LRS for qualifying GAF products. For installations not eligible for the *WindProven™ Limited Wind Warranty*, see *GAF Shingle & Accessory Limited Warranty* for complete coverage and restrictions.

NOTE: It is difficult to reproduce the color clarity and actual color blends of these products. Before selecting your color, please ask to see several full-size shingles.

Available regionally

Designer Lifetime[†] Shingles Collection

Sophisticated designs, custom color palettes, and high performance, GAF Lifetime[†] designer shingles are only a fraction of the cost of traditional slate or wood shakes.

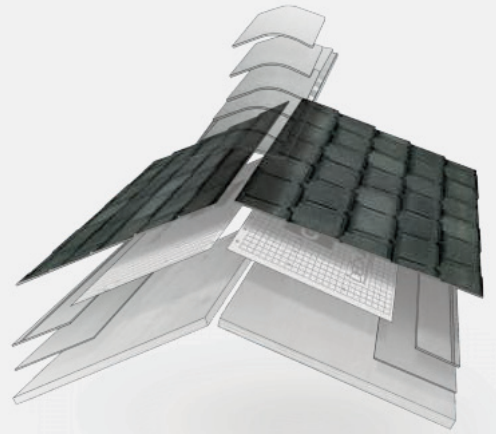

Designer Lifetime[†] Shingles Collection

<p>Grand Sequoia[®] pg 11</p>			<p>Rustic charm meets 21st-century style</p>
<p>Camelot II[®] pg 12</p>			<p>Contemporary slate-inspired elegance in an asphalt shingle</p>
<p>Woodland[®] pg 12</p>			<p>The beauty of natural wood shakes in an asphalt shingle</p>
<p>Slateline[®] pg 13</p>			<p>An asphalt shingle with the dramatic look of slate</p>

For specifications see pages 20–21



For the full collection visit gaf.com/Designer



[†] 25-year StainGuard Plus™ Algae Protection Limited Warranty against blue-green algae discoloration is available only on products sold in packages bearing the StainGuard Plus™ logo. See *GAF Shingle & Accessory Limited Warranty* for complete coverage and restrictions.

GAF Grand Sequoia®
Designer Lifetime† Shingles

Artisan-crafted shapes combined with oversized tabs result in a sophisticated beauty unmatched by typical shingles.

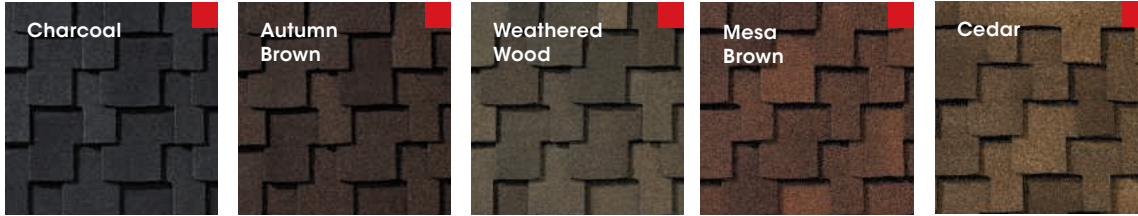

For more details visit gaf.com/GrandSequoia

†25-year StainGuard Plus™ Algae Protection Limited Warranty against blue-green algae discoloration is available only on products sold in packages bearing the StainGuard Plus™ logo. See *GAF Shingle & Accessory Limited Warranty* for complete coverage and restrictions.

NOTE: It is difficult to reproduce the color clarity and actual color blends of these products. Before selecting your color, please ask to see several full-size shingles.

GAF Camelot® II
Designer Lifetime+ Shingles

Designed to complement your exterior color scheme, these shingles give your home an artisanal, slate-like roof aesthetic.

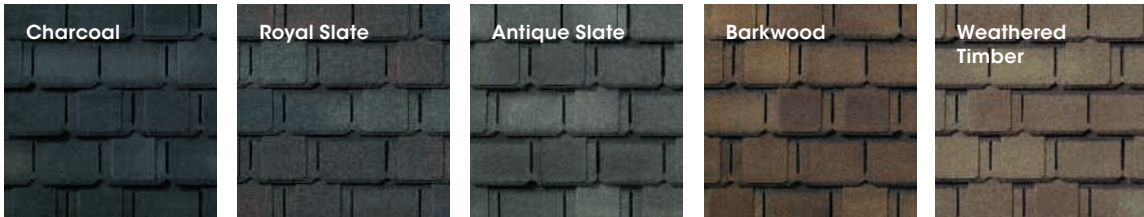

For more details visit gaf.com/CamelotII

GAF Woodland®
Designer Lifetime+ Shingles

The stylish look of hand-cut European shingles at an incredibly affordable price.



For more details visit gaf.com/Woodland

¹ 25-year StainGuard Plus™ Algae Protection Limited Warranty against blue-green algae discoloration is available only on products sold in packages bearing the StainGuard Plus™ logo. See *GAF Shingle & Accessory Limited Warranty* for complete coverage and restrictions.

GAF Slateline®
Designer Lifetime[†] Shingles



Bold shadow lines and tapered cut-outs create the look of slate at a fraction of the cost.



For more details visit gaf.com/Slateline

Designer Lifetime[†] Shingles Collection LRS

[†]25-year StainGuard Plus™ Algae Protection Limited Warranty against blue-green algae discoloration is available only on products sold in packages bearing the StainGuard Plus™ logo. See *GAF Shingle & Accessory Limited Warranty* for complete coverage and restrictions.
NOTE: It is difficult to reproduce the color clarity and actual color blends of these products. Before selecting your color, please ask to see several full-size shingles.

SBS-Modified Impact-Resistance (IR) Shingles Collection

Engineered with SBS-modified asphalt to really take a punch from Mother Nature.

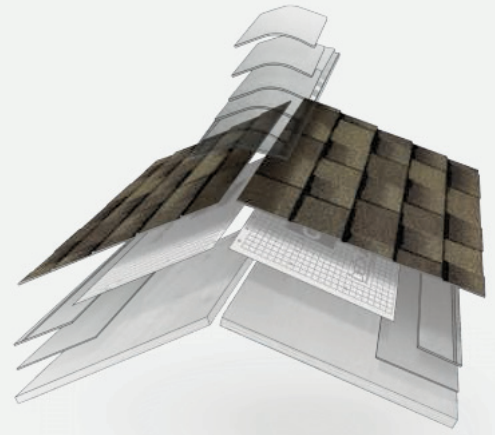

<p>Timberline® AS II</p> <p>pg 15</p>			<p>UL2218 Class 4 impact resistance to help protect your most valuable asset</p>
<p>Grand Sequoia® AS</p> <p>pg 15</p>			<p>The look of rugged wood shakes in an asphalt shingle with UL2218 Class 4 impact resistance</p>

For specifications see pages 20–21

UL 2218 Class 4 Impact-Resistance Test

A 2" steel ball drops twice from a 20' height onto various target locations to evaluate the shingles' ability to withstand the impact.



⊗ Fail

✓ Pass

Result on a standard shingle

Evidence of visible ruptures or cracks through the shingle immediately after impact

Results on a Class 4 shingle

No evidence of ruptures or cracks through the shingle immediately after impact



For the full collection visit gaf.com/ArmorShield

¹ 15-year WindProven™ Limited Wind Warranty on GAF shingles with LayerLock® Technology requires the use of GAF starter strips, roof deck protection, ridge cap shingles, and leak barrier or attic ventilation. See *GAF Roofing System Limited Warranty* for complete coverage and restrictions. Visit gaf.com/LRS for qualifying GAF products. For installations not eligible for the *WindProven™ Limited Wind Warranty*, see the *GAF Shingle & Accessory Limited Warranty*.

² 25-year StainGuard Plus™ Algae Protection Limited Warranty against blue-green algae discoloration is available only on products sold in packages bearing the StainGuard Plus™ logo. See *GAF Shingle & Accessory Limited Warranty* for complete coverage and restrictions.

NOTE: It is difficult to reproduce the color clarity and actual color blends of these products. Before selecting your color, please ask to see several full-size shingles.



GAF **Timberline® ASII**
ArmorShield® II SBS-Modified IR Shingles

Crafted to pass the UL 2218 Class 4 impact-resistance test, and capture the essence of wood in a thick asphalt design.



For more details visit gaf.com/AS

GAF **Grand Sequoia® AS**
ArmorShield® SBS-Modified IR Shingles

A durable designer shingle with a rugged wood-shake look that passes the UL 2218 Class 4 impact-resistance test.

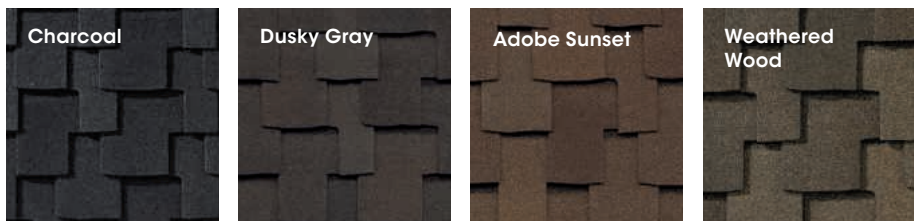

For more details visit gaf.com/GrandSequoiaAS

¹ 15-year WindProven™ Limited Wind Warranty on GAF shingles with LayerLock® Technology requires the use of GAF starter strips, roof deck protection, ridge cap shingles, and leak barrier or attic ventilation. See GAF Roofing System Limited Warranty for complete coverage and restrictions. Visit gaf.com/LRS for qualifying GAF products. For installations not eligible for the WindProven™ Limited Wind Warranty, see the GAF Shingle & Accessory Limited Warranty.

² 25-year StainGuard Plus™ Algae Protection Limited Warranty against blue-green algae discoloration is available only on products sold in packages bearing the StainGuard Plus™ logo. See GAF Shingle & Accessory Limited Warranty for complete coverage and restrictions.

NOTE: It is difficult to reproduce the color clarity and actual color blends of these products. Before selecting your color, please ask to see several full-size shingles.

Reflective Shingles Collection

Engineered with proprietary EcoDark® granules to deliver reflective shingles in rich, dark colors, including Charcoal.

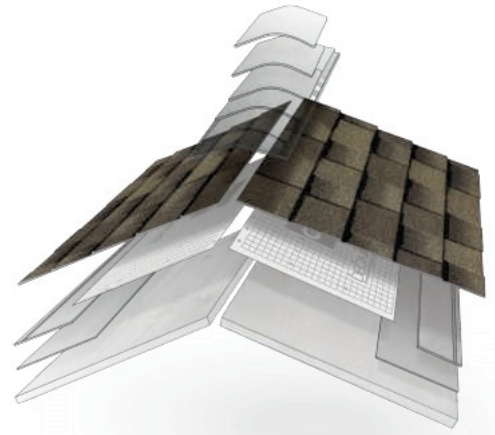

<p>Timberline HDZ® RS</p> <p>pg 17</p>			<p>Popular shingle brand complies with both the Cool Roof requirements of Title 24 and the LA County Green Building Standards code</p>
<p>Grand Sequoia® RS</p> <p>pg 17</p>			<p>Rugged, oversized features and also complies with California Cool Roof requirements</p>

For specifications see pages 20-21

California Climate Zones

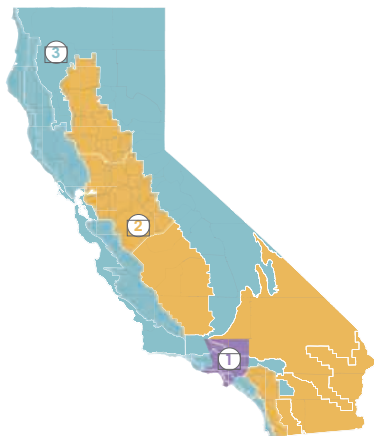

Area/Location	SRI	Requirements	Shingle Color Options
<p>1 Los Angeles County</p>	<p>20</p>	<p>Mandatory</p>	<p>Timberline HDZ® RS: all colors Timberline HDZ®: Birchwood & Golden Amber</p>
<p>2 Climate zones 10-15 (Title 24, Part 6)</p>	<p>16</p>	<p>Tradeoff</p>	<p>Timberline HDZ® RS: all colors Timberline HDZ®: Birchwood, Copper Canyon & Golden Amber Grand Sequoia® RS: all colors</p>
<p>3 Climate zones 1-9, 16 (Title 24, Part 6)</p>	<p>None</p>	<p>No requirements</p>	<p>Timberline HDZ®: all colors</p>



For the full collection visit gaf.com/cool

¹ Can be used to comply with the Cool Roof Requirements for steep-slope residential buildings of 2022 Title 24, Part 6, of the California Code of Regulations and the Green Building Standards Code of Los Angeles County.

¹ 15-year WindProven™ Limited Wind Warranty on GAF shingles with LayerLock® Technology requires the use of GAF starter strips, roof deck protection, ridge cap shingles, and leak barrier or attic ventilation. See *GAF Roofing System Limited Warranty* for complete coverage and restrictions. Visit gaf.com/LRS for qualifying GAF products. For installations not eligible for the *WindProven™ Limited Wind Warranty*, see *GAF Shingle & Accessory Limited Warranty* for complete coverage and restrictions.

² 25-year StainGuard Plus™ Algae Protection Limited Warranty against blue-green algae discoloration is available only on products sold in packages bearing the StainGuard Plus™ logo. See *GAF Shingle & Accessory Limited Warranty* for complete coverage and restrictions, and qualifying products.

GAF Timberline HDZ[®] RS

Reflector Series™ Lifetime[†] Shingles

A reflective shingle line that can deliver deep, vivid colors and the 25-year StainGuard Plus™ Algae Protection Limited Warranty.

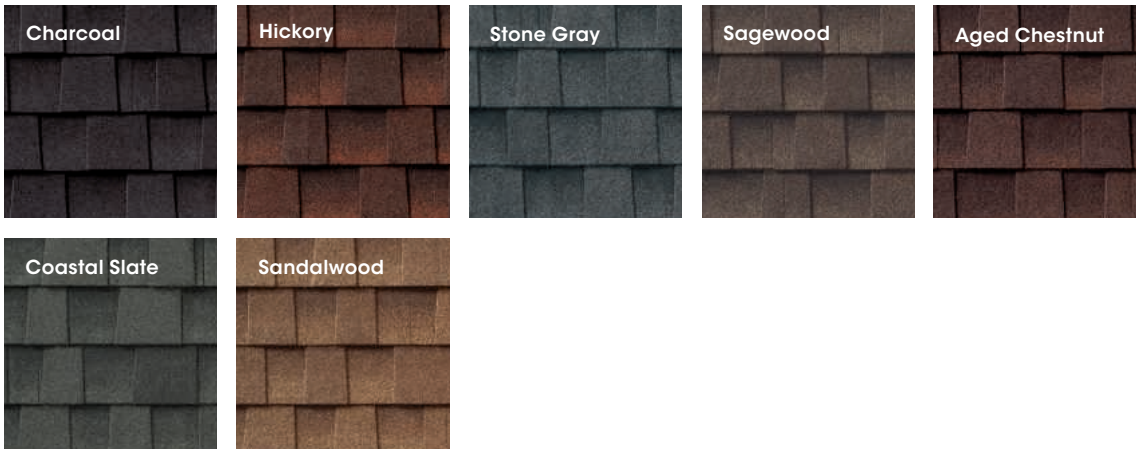

For more details visit gaf.com/HDZRS

GAF GrandSequoia[®] RS

Reflector Series™ Lifetime[†] Shingles

A reflective shingle line with rustic contours for an organic look.

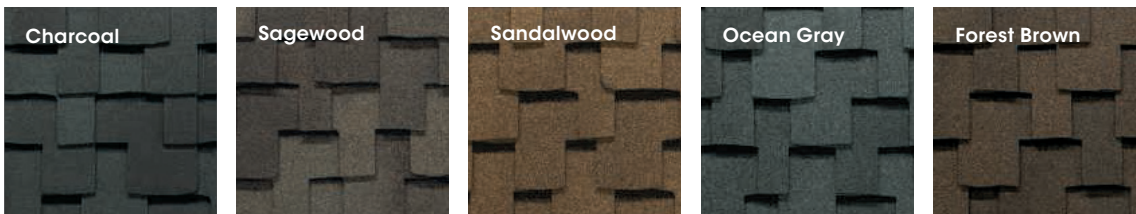

For more details visit gaf.com/GSRS

3-Tab Shingles

The perfect choice for first-time buyers, these shingles add beauty and performance to any roof.

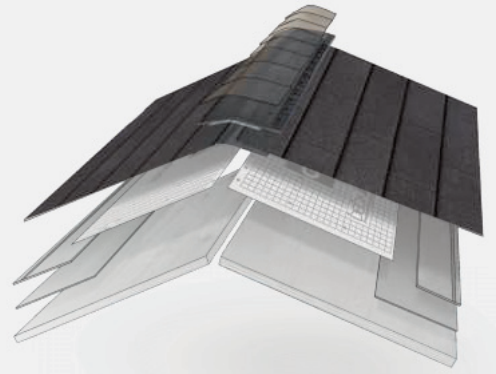

Royal Sovereign®

pg 18-19



Excellent performance and a vivid design make for an exceptional investment

For specifications see pages 20-21

3-Tab Shingles (Excluded from LRS)



For the full collection visit gaf.com/3Tab



³ 10-year StainGuard® Algae Protection Limited Warranty against blue-green algae discoloration is available only on products sold in packages bearing the StainGuard® logo. See *GAF Shingle & Accessory Limited Warranty* for complete coverage and restrictions, and qualifying products.

NOTE: It is difficult to reproduce the color clarity and actual color blends of these products. Before selecting your color, please ask to see several full-size shingles.

GAF Royal Sovereign[®]

3-Tab Shingles

Beautiful. Reliable. Affordable.

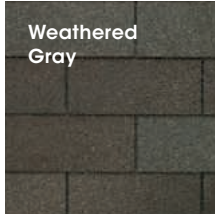
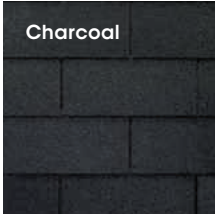

3-Tab Shingles (Excluded from LRS)

Shingle Specifications

Shingle	Warranty	Technology	Shingle Construction
Timberline® Lifetime[†] Shingles Collection			
Timberline HDZ®	† 1 2		
Timberline UHDZ®	† 1 2		
Timberline® NS	† 2		
Designer Lifetime[†] Shingles Collection			
Grand Sequoia®	† 2		
Woodland®	† 2		
Camelot® II	† 2		
Slateline®	† 2		
SBS-Modified IR Shingles Collection			
Timberline® AS II	† 1 2		
Grand Sequoia® AS	† 2		
Reflective Shingles Collection			
Timberline HDZ® RS	† 1 2		
Grand Sequoia® RS	† 2		
3-Tab Shingle			
Royal Sovereign®	3 2		

[†] Lifetime refers to the length of warranty coverage provided and means as long as the original individual owner(s) of a single-family detached residence [or eligible second owner(s)] owns the property where the qualifying GAF products are installed. For other owners/structures, Lifetime coverage is not applicable. Lifetime coverage on shingles requires the use of GAF Lifetime shingles only. See the *GAF Shingle & Accessory Limited Warranty* for complete coverage and restrictions. Visit gaf.com/LRS for qualifying GAF products. Lifetime coverage on shingles and accessories requires the use of any GAF Lifetime shingle and at least 3 qualifying GAF accessories. See the *GAF Roofing System Limited Warranty* for complete coverage and restrictions. For installations not eligible for the *GAF Roofing System Limited Warranty*, see the *GAF Shingle & Accessory Limited Warranty*. Visit gaf.com/LRS for qualifying GAF products.

¹ 15-year WindProven™ Limited Wind Warranty on GAF shingles with LayerLock® Technology requires the use of GAF starter strips, roof deck protection, ridge cap shingles, and leak barrier or attic ventilation. See *GAF Roofing System Limited Warranty* for complete coverage and restrictions. Visit gaf.com/LRS for qualifying GAF products. For installations not eligible for the *WindProven™ Limited Wind*, see the *GAF Shingle & Accessory Limited Warranty*.

² 10-year StainGuard™, 25-year StainGuard Plus™, and 30-year StainGuard Plus PRO™ Algae Protection Limited Warranties (as indicated) against blue-green algae discoloration are available only on products sold in packages bearing the StainGuard Plus™, or StainGuard Plus PRO™ logos. See *GAF Shingle & Accessory Limited Warranty* for complete coverage, restrictions, and qualifying products.



Approximate Physical Attributes					Codes										Special Features			
					Fire	Wind		National			Regional							
Pieces/Squares	Bundles/Squares	Nails/Squares ⁴	Exposure	Dimensions	UL Listed to ANSI/AUL 790 Class A	ASTM D7158, Class H	ASTM D3161, Class F	ASTM D3018 Type 1	ASTM D3462 ⁵	Classified in accordance with ICC-ES AC438	Miami-Dade County Product Control Approved	State of Florida Approved	Texas Department of Insurance Listed	ICC-ES ESR-1475	ICC-ES ESR-3267	UL 2218 Class 3	UL 2218 Class 4	Cool Roof Rating Council (CRRC) Rated
64	3	256	5 5/8" (143 mm)	13 1/4" x 39 3/8" (337 x 1,000 mm)	●	●	●	●	●	●	6	●	●	●	●	●	●	7
64	3	256	5 5/8" (143 mm)	13 1/4" x 39 3/8" (337 x 1,000 mm)	●	●	●	●	●	●	6	●	●	●	●	●	●	
64	3	256	5 5/8" (143 mm)	13 1/4" x 39 3/8" (337 x 1,000 mm)	●	●	●	●	●	●	6	●	●	●	●			
72	5	360	5" (127 mm)	17" x 40" (432 x 1,016 mm)	●	●	●	●	●	●	●	●	●	●	●			
56	4	280	6 1/2" (165 mm)	17" x 40" (432 x 1,016 mm)	●	●	●	●	●	●	●	●	●	●	●			
56	4	280	7 1/2" (191 mm)	17" x 34 1/2" (432 x 876 mm)	●	●	●	●	●	●	●	●	●	●	●			
48	3	288	7 1/2" (191 mm)	17" x 40" (432 x 1,016 mm)	●	●	●	●	●	●	●	●	●	●	●			
64	3	256	5 5/8" (143 mm)	13 1/4" x 39 3/8" (337 x 1,000 mm)	●	●	●	●	●	●	●	●	●	●	●	●	●	
72	4	360	5" (127 mm)	17" x 40" (432 x 1,016 mm)	●	●	●	●	●	●	●	●	●	●	●	●	●	
64	3	256	5 5/8" (143 mm)	13 1/4" x 39 3/8" (337 x 1,000 mm)	●	●	●	●	●	●	●	●	●	●	●	●	●	●
72	4	360	5" (127 mm)	17" x 40" (432 x 1,016 mm)	●	●	●	●	●	●	●	●	●	●	●	●	●	●
English 79	3	English 316	English 5" (127 mm)	English 12" x 36" (305 x 914 mm)	●	●	●	●	●	●	6	●	●	6	●			
Metric 64		Metric 256	Metric 5 5/8" (143 mm)	Metric 13 1/4" x 39 3/8" (337 x 1,000 mm)	●	●	●	●	●	●	●	●	●	●	●			

³See GAF Shingle & Accessory Limited Warranty for complete coverage and restrictions.

⁴Steeper slopes and maximum wind warranties may require more nails.

⁵Periodically tested by independent and internal labs to ensure compliance with ASTM D3462 at time of manufacture.

⁶Applies to some plants (that make referenced product).

⁷Applies to Birchwood, Copper Canyon, and Golden Amber only.







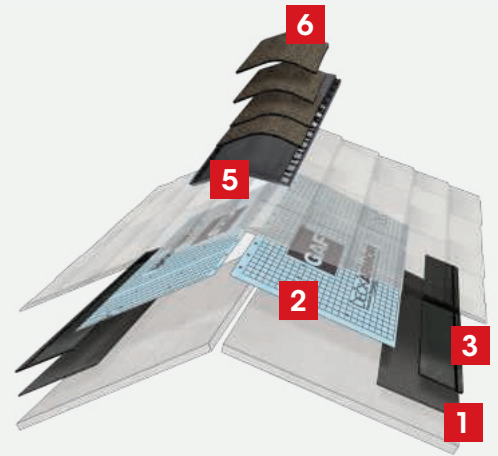





Roofing Accessories

Install any GAF Lifetime[†] shingle and at least 3 qualifying GAF accessories and you'll get a Lifetime[†] Limited Warranty on your qualifying GAF products.



Visit gaf.com/LRS for a list of qualifying products.

Leak Barriers pg 23			Help prevent leaks caused by wind-driven rain and ice dams
Roof Deck Protection pg 24			Helps shield the roof deck from moisture infiltration
Starter Strip Shingles pg 25			Help guard against shingle blow-offs at the eaves and rakes
Attic Ventilation pg 26-27			Helps reduce excessive attic heat and moisture
Ridge Cap Shingles pg 28			Help defend against leaks at the hips and ridges



For the full collection visit gaf.com/Lifetime

[†] Lifetime refers to the length of warranty coverage provided and means as long as the original individual owner(s) of a single-family detached residence [or eligible second owner(s)] owns the property where the qualifying GAF products are installed. For other owners/structures, Lifetime coverage is not applicable. Lifetime coverage on shingles requires the use of GAF Lifetime shingles only. See the *GAF Shingle & Accessory Limited Warranty* for complete coverage and restrictions. Visit gaf.com/LRS for qualifying GAF products. Lifetime coverage on shingles and accessories requires the use of any GAF Lifetime shingle and at least 3 qualifying GAF accessories. See the *GAF Roofing System Limited Warranty* for complete coverage and restrictions. For installations not eligible for the *GAF Roofing System Limited Warranty*, see the *GAF Shingle & Accessory Limited Warranty*. Visit gaf.com/LRS for qualifying GAF products

[†] 15-year WindProven™ Limited Wind Warranty on GAF shingles with LayerLock® Technology requires the use of GAF starter strips, roof deck protection, ridge cap shingles, and leak barrier or attic ventilation. See *GAF Roofing System Limited Warranty* for complete coverage and restrictions. Visit gaf.com/LRS for qualifying GAF products. For installations not eligible for the *GAF WindProven™ Limited Wind Warranty*, see the *GAF Shingle & Accessory Limited Warranty*.



Leak Barriers

Help prevent leaks caused by wind-driven rain and ice dams.

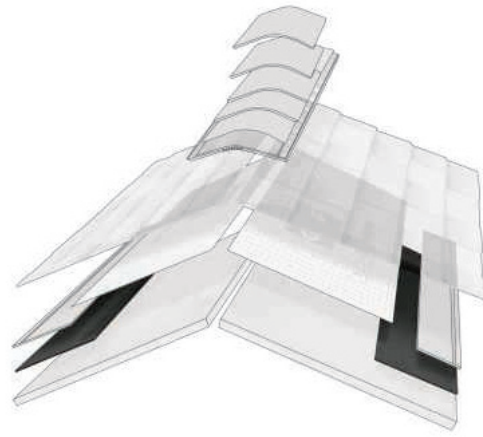

<p>StormGuard®</p>		<ul style="list-style-type: none"> ▪ Patterned synthetic film-surfaced peel-&-stick underlayment for asphalt shingles & metal roofing ▪ Self-seal fasteners, helps protect vulnerable areas of the roof ▪ 250°F high-temperature design, meets or exceeds the performance criteria of ASTM D1970 ▪ 2 Sq. (200 ft.² [18.58 m²]) roll size — excludes laps
<p>WeatherWatch®</p>		<ul style="list-style-type: none"> ▪ Mineral-surfaced peel-&-stick underlayment for asphalt shingles ▪ Self-seal fasteners, helps protect vulnerable areas of the roof ▪ Meets or exceeds the performance criteria of ASTM D1970 ▪ 2 Sq. (200 ft.² [18.58 m²]) & 1.5 Sq. (150 ft.² [13.94 m²]) roll sizes — excludes laps

Leak Barrier Application Recommendations:

Strongly recommended around	Optional around	Required by code at ¹	Region ¹
1. Penetrations	5. Hips & rake edges	7. Eaves in colder zones <i>Recommended in warmer zones</i>	1. Colder zone
2. Skylights	6. Ridges		2. Warmer zone
3. Valleys & dormers	4. Flashings & transitions		

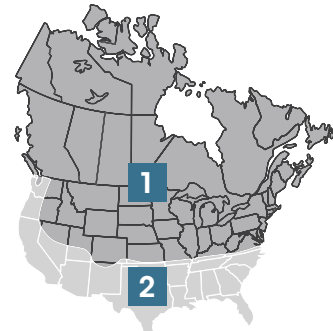
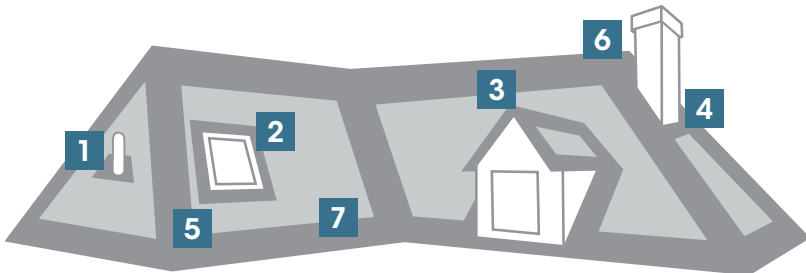

For the full collection visit gaf.com/LeakBarriers

¹ Always check local building codes for requirements in your area.

* To qualify for this coverage, must be installed with GAF Lifetime¹ shingles and at least 2 additional qualifying GAF accessories. See GAF.com/LRS for qualifying products and see GAF Roofing System Limited Warranty for complete coverage and restrictions.

Roof Deck Protection

Helps shield the roof deck from moisture infiltration.

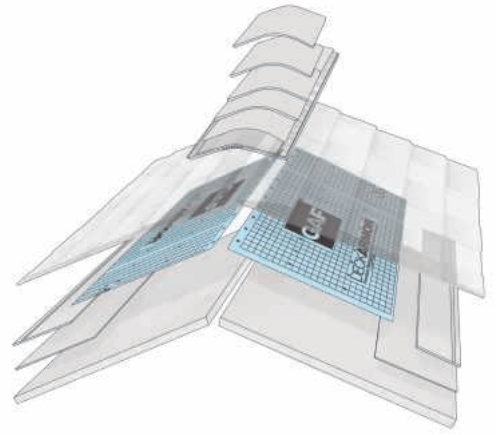

<h2>Deck-Armor™</h2>		<ul style="list-style-type: none"> ▪ Premium breathable synthetic underlayment for asphalt shingles & other roof systems ▪ Nom. 16 perms,¹ high-traction surface & tear-resistant construction ▪ 48" x 250' (1.22 m x 76.2 m); 10 Sq. (1,000 ft.² [92.9 m²]) roll size — excludes laps
<h2>Tiger Paw™</h2>		<ul style="list-style-type: none"> ▪ Premium synthetic underlayment for asphalt shingles & other roof systems ▪ High-traction surface, tear-resistant construction & deck side coating provides moisture control ▪ 48" x 250' (1.22 m x 76.2 m); 10 Sq. (1,000 ft.² [92.9 m²]) roll size — excludes laps
<h2>FeltBuster®</h2>		<ul style="list-style-type: none"> ▪ High-traction synthetic underlayment for asphalt shingles ▪ Value-priced, high-traction surface & tear-resistant construction ▪ 48" x 250' (1.22 m x 76.2 m); 10 Sq. (1,000 ft.² [92.9 m²]) roll size — excludes laps
<h2>Shingle-Mate™</h2>		<ul style="list-style-type: none"> ▪ Fiberglass-reinforced underlayment for asphalt shingles ▪ Fiberglass reinforcement lays flat & helps prevent telegraphing through shingles ▪ 36" x 144' (914 m x 43.89 m); 4 Sq. (432 ft.² [40.13 m²]) roll size — excludes laps
<h3>Specialty Underlayment</h3>		
<h2>VersaShield®</h2>		<ul style="list-style-type: none"> ▪ Fiberglass-reinforced fire-resistant underlayment for asphalt shingles, metal, wood & other roof systems ▪ Helps upgrade the UL Fire Rating of many roofing systems (always see the UL Certification Directory) & helps resist dangerous flame spread ▪ 42" x 100' (1.07 m x 30.48 m); 3.5 Sq. (350 ft.² [32.5 m²]) roll size — excludes laps

For the full collection visit gaf.com/RoofDeckProtection

^{*} To qualify for this coverage, must be installed with GAF Lifetime¹ shingles and at least 2 additional qualifying GAF accessories. See GAF.com/LRS for qualifying products and see *GAF Roofing System Limited Warranty* for complete coverage and restrictions.

Starter Strip Shingles

Help guard against shingle blow-offs at the eaves and rakes.

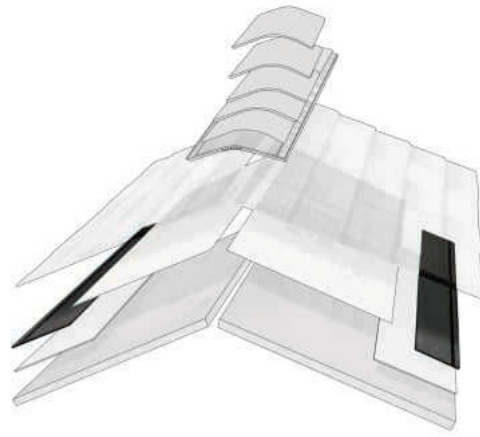

<p>WeatherBlocker™</p>		<ul style="list-style-type: none"> ▪ Premium starter strip shingles specifically designed to be compatible with all asphalt shingles ▪ Extra-wide format, pre-perforated design & high-quality factory-applied Dura Grip™ adhesive ▪ Full sheets measure 17" x 40" (432 mm x 1,016 mm) & cover 50 lin. ft. (15 lm) per bundle, half sheets measure 8 ½" x 40" (216 mm x 1,016 mm) & cover 100 lin. ft. (31 lm) per bundle
<p>Pro-Start®</p>		<ul style="list-style-type: none"> ▪ Cost-effective starter strip shingles for most standard English & metric-sized asphalt shingles ▪ Pre-perforated design with high-quality factory-applied Dura Grip™ adhesive ▪ Full sheets measure 13" x 38" (330 mm x 965 mm) & are split into half sheets measuring 6 ½" x 38" (165 x 965 mm) to cover 120.33 lin. ft. (36.69 lm) per bundle
<p>QuickStart®</p>		<ul style="list-style-type: none"> ▪ Peel-&stick starter strip roll for most standard English & metric-sized asphalt shingles ▪ Mineral surfacing with factory-applied Dura Grip™ adhesive ▪ 9" x 33' (228 mm x 10 m) roll size
<p>StarterMatch®</p>		<ul style="list-style-type: none"> ▪ Complementary-color starter strip shingles for Grand Sequoia® shingles ▪ 25-year StainGuard Plus™ Algae Protection™ Limited Warranty protects StarterMatch® starter strip shingles from unsightly stains¹ ▪ Used in conjunction with WeatherBlocker™ premium starter strip shingles ▪ Full sheets measure 13 ¼" x 40" (337 mm x 1,016 mm) & cover 60 lin. ft. (18.3 lm) per bundle

For the full collection visit gaf.com/StarterStrip

* To qualify for this coverage, must be installed with GAF Lifetime¹ shingles and at least 2 additional qualifying GAF accessories. See GAF.com/LRS for qualifying products and see *GAF Roofing System Limited Warranty* for complete coverage and restrictions.

¹ 25-year StainGuard Plus™ Algae Protection Limited Warranty against blue-green algae discoloration is available only on products sold in packages bearing the StainGuard Plus™ logo. See *GAF Shingle & Accessory Limited Warranty* for complete coverage and restrictions, and qualifying products.

GAF AtticVentilation

Helps reduce excessive attic heat, moisture, ice dams, and premature roof system degradation.†

GAF Cobra®
Attic Ventilation Products

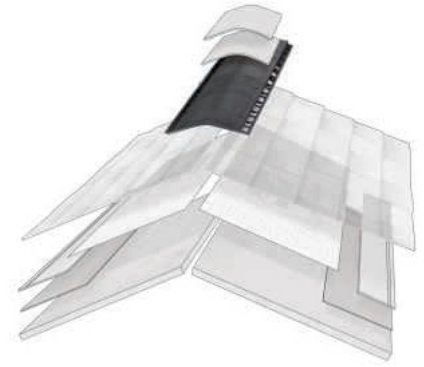

Ridge & Hip Exhaust Ventilation

<p>Cobra® Exhaust Vent</p>		<ul style="list-style-type: none"> ▪ Mesh roll ridge vent for all climates ▪ 10 ½" (267 mm), 8" (203 mm) & 11 ¾" (298 mm) widths; 20' (6.1 m) & 50' (15.24 m) lengths ▪ Includes 2 ½" (64 mm) Smart Nails™ (hand nailable) or 1 ¾" (44 mm) coil nails (nail gunnable) ▪ NFA: hand nailable — 16.9 sq. in./lin. ft. (35,772 mm² per linear meter); nail gunnable — 14.1 sq. in./lin. ft. (29,845 mm² per linear meter)
<p>Cobra® SnowCountry® Advanced</p>		<ul style="list-style-type: none"> ▪ Premium filtered plastic ridge vent for colder climates ▪ Includes 3" (76 mm) ring shank nails, Snow Guard™ filter & 3" (76 mm) EasyTear® sizing ▪ 11 ½" (292 mm) and 9" (229 mm) widths; 4' (1.2 m) length, 40 lin. ft. (12.2 lm) per box ▪ NFA: 18 sq. in./lin. ft. (38,100 mm² per linear meter)
<p>Cobra® SnowCountry®</p>		<ul style="list-style-type: none"> ▪ Plastic filtered ridge vent for colder climates ▪ Includes Snow Guard™ filter & 3" (76 mm) EasyTear® sizing ▪ 11 ½" (292 mm) width; 4' (1.2 m) length, 40 lin. ft. (12.2 lm) per box ▪ NFA: 18 sq. in./lin. ft. (38,100 mm² per linear meter)
<p>Cobra® Rigid Vent 3™</p>		<ul style="list-style-type: none"> ▪ Premium non-filtered plastic ridge vent for warmer climates ▪ Includes 3" (76 mm) ring shank nails & 3" (76 mm) EasyTear® sizing ▪ 11 ½" (292 mm) & 9" (229 mm) widths; 4' (1.2 m) length, 40 lin. ft. (12.2 lm) per box ▪ NFA: 18 sq. in./lin. ft. (38,100 mm² per linear meter)
<p>Cobra® RidgeRunner®</p>		<ul style="list-style-type: none"> ▪ Plastic roll ridge vent for all climates ▪ Includes 1 ¾" (44 mm) ring shank coil nails, Weather Fighter® filter (non-filtered version also available in warmer climates) & 12" (305 mm) EasyTear® sizing ▪ 11 ½" (292 mm) width; 30' (9.1 m) length ▪ NFA: 12.5 sq. in./lin. ft. (26,458 mm² per linear meter)
<p>Cobra® Hip Vent</p>		<ul style="list-style-type: none"> ▪ Plastic hip vent for all climates ▪ Includes 1 ¾" (44 mm) ring shank coil nails & Dual Weather Fighter® filter ▪ 11 ½" (292 mm) width; 4' (1.2 m) length, 40 lin. ft. (12.2 lm) per box ▪ NFA: 9 sq. in./lin. ft. (19,050 mm² per linear meter)

Rooftop Intake Ventilation

<p>Cobra IntakePro®</p>		<ul style="list-style-type: none"> ▪ Tapered roll intake vent for all climates ▪ Includes 1 ¾" (44 mm) coil nails and end cap fabric ▪ 11" (279 mm) width; 20' (6.1 m) length ▪ NFA: 9 sq. in./lin. ft. (19,050 mm² per linear meter) 1. See photo for product placement
--------------------------------	--	---







For more details visit gaf.com/Ventilation

* Cobra® Attic Ventilation Products are eligible for this coverage and must be installed with GAF Lifetime shingles and at least 2 additional qualifying GAF accessories. See gaf.com/LRS for qualifying products.

† NOTE: Always have a balanced attic ventilation system. In no case should the amount of exhaust ventilation at or near the ridge exceed the amount of intake ventilation at or near the soffit. Visit gaf.com/ventcalculator for more details.



Off-Ridge Exhaust Ventilation

Roof mount power attic vents		<ul style="list-style-type: none"> ▪ Exhaust large amounts of heat & moisture from the attic ▪ Hardwired electric or EZ Cool™ plug-in options ▪ High-efficiency PSC motors ▪ Thermostat control included on all models, optional combination humidistat/thermostat control available on select models ▪ Available with optional QuickConnect™ Wi-Fi technology ▪ Available in popular colors to complement most finished roofs 	
Solar-powered vents		<ul style="list-style-type: none"> ▪ Help reduce electricity costs associated with operating a fully electric powered vent² ▪ Available in both solar-powered & unique dual-powered models ▪ Solar-powered models run off the sun's power, while dual-powered models switch automatically between sun & house power ▪ Thermostat or combo humidistat/thermostat control available on select models 	
Roof louvers		<ul style="list-style-type: none"> ▪ Allow heat & moisture to escape the attic on roofs with limited ridge ▪ Styles: slant-back, square-top, dome ▪ Construction: aluminum, galvanized & plastic (models with optional weather/ember-resistant screen³ also available) ▪ NFA per vent: Options from 37–144 sq. in. (23,871–92,903 mm²) 	
Aluminum ridge vent		<ul style="list-style-type: none"> ▪ Allow heat & moisture to escape the attic ▪ Construction: aluminum with built-in baffle ▪ NFA per vent: 21.5 sq. in. per lin. ft. (45,508 mm² per linear meter) 	
Wind turbines		<ul style="list-style-type: none"> ▪ Use wind power to pull heat & moisture from the attic ▪ Sizes: 12" (305 mm) & 14" (356 mm) ▪ Construction: aluminum internally braced, galvanized internally or externally braced 	

Undereave Intake Ventilation

Soffit/undereave intake vents		<ul style="list-style-type: none"> ▪ Allow cooler dry air to enter the attic ▪ Styles: continuous, oval, rectangular, EmberShield® closeable³ ▪ NFA per vent: Options from 22–68 sq. in (14,194–43,871 mm²)
--------------------------------------	---	--

For the full collection visit gaf.com/Ventilation

¹ While Master Flow™ Attic Ventilation Products are not eligible for Lifetime Limited Warranty coverage under the GAF Roofing System Limited Warranty, they are covered separately by the Master Flow™ Powered Ventilation Products Limited Warranty, Master Flow™ Ventilation Products Limited Warranty, or Master Flow™ Wi-Fi Attic Vent Limited Warranty, depending on product.

² Energy cost savings are not guaranteed and the amount of savings may vary based on climate zone, utility rates, radiative properties of roofing products, insulation levels, HVAC equipment efficiency, and other factors.

³ GAF makes no express or implied warranty about the fire performance of this product against Wildfire Exposure. Fire damage is not covered under the limited warranty. Please see the GAF Master Flow™ Ventilation Products Limited Warranty for complete coverage and restrictions.

NOTE: Always have a balanced attic ventilation system. In no case should the amount of exhaust ventilation at or near the ridge exceed the amount of intake ventilation at or near the soffit. Visit gaf.com/ventcalculator for more details.

Ridge Cap Shingles

Helps defend against leaks at the hips and ridges.



<p>TimberTex[®]</p>			<ul style="list-style-type: none"> ▪ Premium double-layer ridge cap shingles for use with Timberline HDZ[®], Timberline[®] NS, Timberline UHDZ[®] & GAF Lifetime[†] designer shingles ▪ Pre-perforated design & factory-applied Dura Grip[™] adhesive ▪ 12" (305 mm) width 8" (203 mm) exposure, covers 20 lin. ft. (6.1 lm) per bundle ▪ Passes UL 2218 Impact-Resistance Test with Class 3 rating² ▪ Available in all areas (except West area)
<p>Seal-A-Ridge[®]</p>			<ul style="list-style-type: none"> ▪ Traditional-look ridge cap shingles for use with Timberline HDZ[®], Timberline[®] NS & Timberline UHDZ[®] shingles ▪ Pre-perforated design & factory-applied Dura Grip[™] adhesive ▪ 12" (305 mm) width, 6 2/3" (169 mm) exposure, covers 25 lin. ft. (7.6 lm) per bundle ▪ Passes UL 2218 Impact-Resistance Test with Class 3 rating² ▪ Available in all areas
<p>TimberCrest[®]</p>		 	<ul style="list-style-type: none"> ▪ Premium SBS-modified bullnose ridge cap shingles for use with Timberline HDZ[®], Timberline[®] NS, Timberline UHDZ[®], Timberline HDZ[®] RS & GAF Lifetime[†] designer shingles. Available in the Southwest for GAF ArmorShield[™] series shingles. ▪ Pre-folded/flexed design & factory-applied Dura Grip[™] adhesive ▪ UL Class 4 Impact resistance ▪ 10" (254 mm) width, 8" (203 mm) exposure, covers 20 lin. ft. (6.1 lm) per box ▪ Available in the West and Southwest (ArmorShield[™] series shingles) areas
<p>Seal-A-Ridge[®] AS</p>		 	<ul style="list-style-type: none"> ▪ Traditional look SBS-modified ridge cap shingles for use with GAF ArmorShield[™] series shingles ▪ Pre-perforated design & factory-applied Dura Grip[™] adhesive ▪ UL Class 4 impact resistance ▪ 12" (305 mm) width, 5" (127 mm) exposure, covers 25 lin. ft. (7.6 lm) per bundle ▪ Available in all areas
<p>Z[®]Ridge</p>			<ul style="list-style-type: none"> ▪ Wood shake-look ridge cap shingles for use with Timberline HDZ[®], Timberline[®] NS & Timberline UHDZ[®] shingles ▪ Pre-perforated design with unique Z-fold design ▪ 10" (254 mm) width, 5 5/8" (143 mm) exposure, covers 33.3 lin. ft. (10.1 lm) per bundle ▪ Passes UL 2218 Impact-Resistance Test with Class 3 rating² ▪ Available in the Southwest and West areas

For more details visit gaf.com/RidgeCaps

^{*} To qualify for this coverage, must be installed with GAF Lifetime[†] shingles and at least 2 additional qualifying GAF accessories. See GAF.com/LRS for qualifying products and see *GAF Roofing System Limited Warranty* for complete coverage and restrictions.

¹ 25-year StainGuard Plus[™] Algae Protection Limited Warranty against blue-green algae discoloration is available only on products sold in packages bearing the StainGuard Plus[™] logo. See *GAF Shingle & Accessory Limited Warranty* for complete coverage and restrictions, and qualifying products.

² GAF ridge cap shingles are not warranted to withstand hail damage.



Specialty roofing accessories designed to enhance the performance of your residential roofing system by helping to keep it dry, strong, and looking its best.

<p>Pivot™ Pipe Boot Flashing</p>		<p>Premium upgrade for commodity pipe boot flashings & collars</p> <ul style="list-style-type: none"> ▪ All-metal external construction with no exposed seals, gaskets, collars, or caulk ▪ Rooftop pitch adjustment 3:12 – 12:12 ▪ Construction: Galvanized steel ▪ Sizes: 1.5" (38.1 mm), 2" (50.8 mm), 3" (76.2 mm) & 4" (101.6 mm) for Schedule 40 pipe ID opening sizes ▪ Colors: Weathered Wood, Black, Brown, Gray ▪ Warranted against leaks for up to 50 years (or as long as the warranty on the adjacent roof cladding)¹
<p>Versa Cap Adjustable Pipe Cap</p>		<p>Adjustable pipe cap for rooftop flues, hot stacks & B-vent installations</p> <ul style="list-style-type: none"> ▪ Adjustable clamp for easy installation ▪ Positive draft reduces risk of clogging ▪ Construction: Aluminum ▪ Sizes: Options for pipe ODs of 2 7/8" – 10 7/8" (200 mm – 276 mm)
<p>Goose Neck Vents</p>		<p>All-metal bath and dryer vent design that seamlessly integrates with your residential roofing system</p> <ul style="list-style-type: none"> ▪ Streamlined design for weather resistance and enhanced aesthetics ▪ Includes damper and heavy-duty removable screen ▪ Available in galvanized (black) and aluminum (mill)
<p>Chimney Caps</p>		<p>Protects masonry chimneys against weather infiltration, downdrafts, clogging & animal infestation</p> <ul style="list-style-type: none"> ▪ Construction: Galvanized ▪ Sizes: large adjustable, small adjustable & fixed-sizes: 9" x 9", 9" x 13", 13" x 13" (229 mm x 229 mm, 229 mm x 330 mm, 330 mm x 330 mm)
<p>Zinc Moss & Mildew Preventer</p>		<p>Helps resist moss & mildew build-up on steep-slope roofs</p> <ul style="list-style-type: none"> ▪ For use with asphalt, tile & wood roofs ▪ Size: 2 2/3" x 50' (144 mm x 15 m) coils
<p>Other Rooftop Accessories</p>		<p>Storm collars, vent caps, all purpose vents, roof jacks & other flashings</p>

For the full collection visit gaf.com/RooftopAccessories

¹See Master Flow™ Pivot™ Pipe Boot Flashing Limited Warranty for complete coverage and restrictions.

GAF **WeatherSide™**
Fiber-Cement Siding

The one and only solution for replacing old asbestos siding.



Siding — contains NO asbestos¹

<p>Purity™ Shingle</p>		<p>Textured surface with straight, wavy, or thatched edge</p>	<ul style="list-style-type: none"> ▪ Size: 12" x 24" (305 mm x 609 mm) ▪ Exposure: straight & wavy 11" (279 mm), thatched 10 1/2" (267 mm)
<p>Profile Shingle</p>		<p>Striated surface with straight edge</p>	<ul style="list-style-type: none"> ▪ Size: 9" x 32" (227 mm x 813 mm) ▪ Exposure: 8" (203 mm) ▪ Size: 12" x 24" (305 mm x 609 mm) ▪ Exposure: 11" (279 mm) ▪ Size: 14 5/8" x 32" (371 mm x 813 mm) ▪ Exposure: 13 5/8" (346 mm)
<p>Emphasis™ Shingle</p>		<p>Extra-thick wood grain look surface with thatched edge</p>	<ul style="list-style-type: none"> ▪ Size: 14 5/8" x 25 5/32" (371 mm x 639 mm) ▪ Exposure: 13" (330 mm)

Accessories

<p>Siding Backer Strips</p>		<p>Helps protect the vertical seams between each piece of siding against weather infiltration</p>	<ul style="list-style-type: none"> ▪ 9" (227 mm) ▪ 12" (305 mm) ▪ 14" (357 mm)
<p>Hot-dipped Galvanized Siding Nails</p>		<p>Helps provide maximum holding power & an excellent finished look</p>	<ul style="list-style-type: none"> ▪ White, ring shank nails ▪ 1 3/4" (44 mm)
<p>Pre-primed Individual Corners</p>		<p>Completes the outside corners of your WeatherSide™ siding job</p>	<ul style="list-style-type: none"> ▪ 9" (227 mm) ▪ 12" (305 mm) ▪ 14" (357 mm) ▪ Emphasis™ corners

Visit gaf.com/WeatherSide

GAF **LIBERTY™**
SBS Self-Adhering Roofing System



Help protect your low-slope roof when installing a granulated self-adhering roofing system. Installs quickly and easily without the hassles of bulky equipment, unpleasant odors, torches, or open flames on your roof. Perfect for porches, garages, car ports, and sheds.

<p>LIBERTY™ Flashing Cement</p>		<ul style="list-style-type: none"> ▪ A cold-applied bonding agent for SBS-modified asphalt roof systems ▪ 1 Gallon (3.79L) ▪ Meets or exceeds ASTM D4586 Type 1 ▪ Meets or exceeds ASTM D3409
<p>LIBERTY™ Asphalt Primer</p>		<ul style="list-style-type: none"> ▪ A general-purpose foundation coating for all types of asphalt-based roofing materials ▪ 1 Gallon (3.79L) ▪ Meets or exceeds ASTM D41
<p>LIBERTY™ Self-Adhering Base/Ply Sheet</p>		<ul style="list-style-type: none"> ▪ Reinforced with a fiberglass mat, coated in a polymer-modified asphalt ▪ 2 square (216 sq. ft. [20.1 m²]) roll size — excludes laps ▪ Meets or exceeds ASTM D4601 Type II & ASTM D1970
<p>LIBERTY™ Self-Adhering Cap Sheet</p>		<ul style="list-style-type: none"> ▪ An SBS-modified granule-surfaced roofing membrane ▪ 1 square (112 sq. ft. [10.4 m²]) roll size — excludes laps ▪ Meets or exceeds ASTM D6164 Type 1, Grade G

LIBERTY™ Cap Sheet Colors¹:

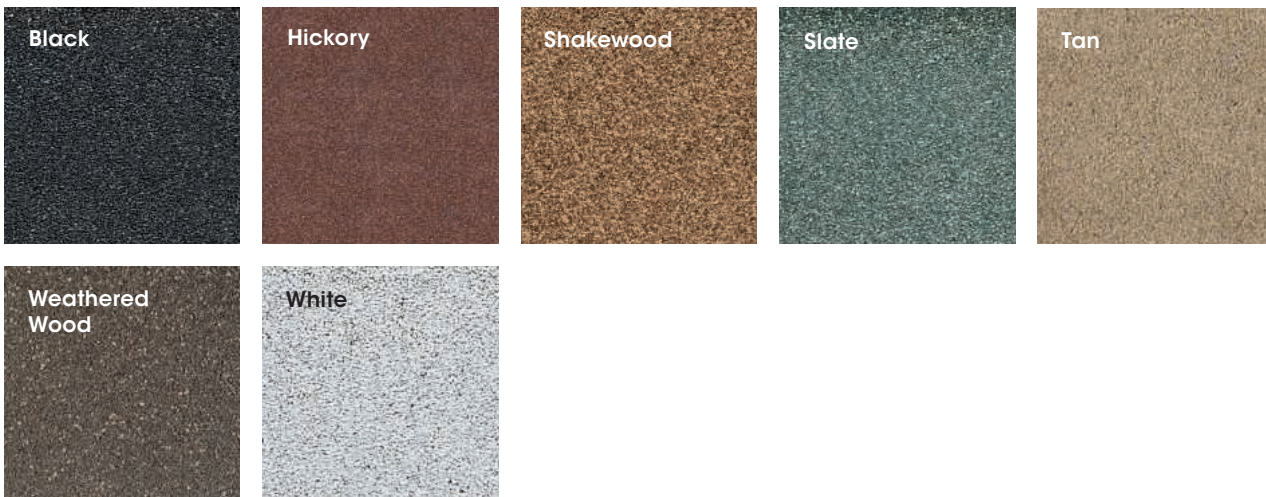

For the full collection visit gaf.com/Liberty

¹ These blended colors are designed to complement your shingles, not to be an exact match. Because of the small size of these samples, it's difficult to reproduce the actual color effect. Please be sure to see a full-size roll before making a final color selection or installing on the roof.

Go beyond for your customers and your business



GAF Timberline **UHDZ**
Ultra High Definition Lifetime Shingles



Go beyond with Timberline UHDZ®

GAF Timberline UHDZ® shingles go beyond any GAF shingle you've been able to offer to date:

Visit gaf.com/uhdz



A **standard** INDUSTRIES COMPANY

We protect what matters most™

GAF

¹ 30-year StainGuard Plus PRO™ Algae Protection Limited Warranty against blue-green algae discoloration is available only on products sold in packages bearing the StainGuard Plus PRO™ logo. See *GAF Shingle & Accessory Limited Warranty* for complete coverage and restrictions.

² 15-year WindProven™ Limited Wind Warranty on GAF shingles with LayerLock® Technology requires the use of GAF starter strips, roof deck protection, ridge cap shingles, and leak barrier or attic ventilation. See *GAF Roofing System Limited Warranty* for complete coverage and restrictions. Visit gaf.com/LRS for qualifying GAF products. For installations not eligible for the *GAF WindProven™ Limited Wind Warranty*, see the *GAF Shingle & Accessory Limited Warranty*.